



**MORE
EXPERIENCE**



**MORE
TECHNOLOGY**



**MORE
EVOLUTION**



**YOUR
BEAUTY
WAY**

Tecnosole[®]

your beauty way ●●●

TANNING & BEAUTY

Tecnosole has been operating in the tanning and beauty sector for over 18 years. During this time, it has established itself on the national and international market developing new high-level technologies and promoting innovations that boast the Made in Italy brand.

High quality materials and exclusive and elegant design characterise Tecnosole products, 100% Made in Italy.

The machines' bright colours and the trendy layout suits any environment, bringing together beauty and wellness.

The natural tanning of Tecnosole solarium is immediately recognizable: uniform, intense and long lasting.

Tecnosole's innovative Intelligent Program guarantees maximum lamp efficiency, safety and energy saving.

Tecnosole è presente nel settore della bellezza e dell'abbronzatura da più di 18 anni, durante questo periodo si è affermata a livello nazionale ed internazionale facendosi apprezzare per l'alto contenuto tecnico ed innovativo dei suoi prodotti, senza però dimenticare il ricercato design Made in Italy che la contraddistingue. Apparecchiature 100% made in Italy, dal design inconfondibile prodotte con materiali di altissima qualità.

Colori brillanti e forme di tendenza che si integrano in qualsiasi contesto dove bellezza e wellness si fondono.

L'abbronzatura naturale dei solarium Tecnosole si riconosce subito: uniforme, intensa e di lunga durata.

L'innovativa tecnologia Intelligent Program di Tecnosole garantisce la massima efficienza, sicurezza e risparmio energetico.

Tecnosole[®]
your beauty way ●●●

**MORE
EXPERIENCE**



**MORE
TECHNOLOGY**



**MORE
EVOLUTION**





ELLIPTIC PROGRAM

The elliptical shape inside the sun shower allows a distance that is as equidistant as possible between the body and the lamps, the tan will be uniform over the whole body.

ELLIPTIC PROGRAM

La forma ellittica all'interno della doccia permette una distanza il più possibile equidistante tra il corpo e le lampade, l'abbronzatura risulterà uniforme su tutto il corpo.



DOUBLE COOLING PROGRAM

The separate body and lamps ventilation ensures perfect cooling and lamps long life. With the exclusive system of the side slits, the body is caressed with a pleasant breeze or with a vortex of power allowing a tan in full relax.

DOUBLE COOLING PROGRAM

La ventilazione separata corpo e lampade garantisce un perfetto raffreddamento e una lunga delle stesse. Grazie all'esclusivo sistema delle feritoie laterali, il corpo è accarezzato con una piacevole brezza o con un vortice di potenza permettendo un'abbronzatura in pieno relax.



BLUETOOTH+RADIO PROGRAM

With the Bluetooth system you can connect your smartphone to listen your favorite music, the volume level and the passage to the subsequent tracks is adjusted directly on the Sensitive Touch Program keyboard. The favourite radio program is available with a simple finger touch.

BLUETOOTH+RADIO PROGRAM

Con il sistema Bluetooth è possibile collegare il proprio smartphone per ascoltare la musica preferita, la regolazione del livello del volume ed il passaggio ai brani successivi avviene direttamente sulla tastiera Sensitive Touch Program. Il programma radio preferito sarà disponibile al semplice tocco di un dito.



NO SHADOW PROGRAM

In all Tecnosole sun showers, the internal building architecture ensures the absence of any shadow areas. The body is thus tanned perfectly uniformly.

NO SHADOW PROGRAM

In tutte le docce Tecnosole il sistema costruttivo interno esclude qualsiasi zona d'ombra. Il corpo risulta così abbronzato perfettamente ed uniformemente.



TOP SOUND PROGRAM

With Top Sound Program the balance and the sound reach the highest levels. The special loud speakers guarantee a "clean and round" sound.

TOP SOUND PROGRAM

Con Top Sound Program il bilanciamento ed il suono raggiungono i massimi livelli. Le speciali casse acustiche garantiscono un suono "pulito e rotondo".

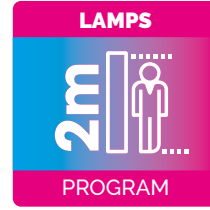

LAMPS PROGRAM

The exclusive Tecnosole lamps guarantee top performance and long life. The 2-meter long tubes are ideal even for the tallest clients.

LAMPS PROGRAM

Le esclusive lampade Tecnosole garantiscono prestazioni e durata. I tubi lunghi 2 metri soddisfano anche i clienti di statura molto alta.

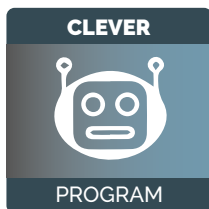

CLEVER PROGRAM

The static magnetic ballasts system allows a low energy absorption with excellent results in terms of tanning. Even the 180 W 2 m long lamps will be performing and durable in time.

CLEVER PROGRAM

Il sistema di alimentazione magnetica statica permette un basso assorbimento di energia con ottimi risultati in materia di abbronzatura. Anche le lampade da 180W lunghe 2 m risulteranno performanti e durevoli nel tempo.



DIGITAL KEYBOARD PROGRAM

The digital keyboard, simple and intuitive, makes it easy for the customer to choose the sun shower functions.

DIGITAL KEYBOARD PROGRAM

La tastiera digitale, semplice e intuitiva, facilita il cliente nella scelta delle funzioni della doccia.

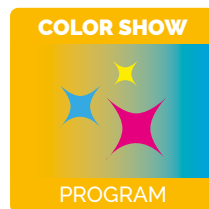

COLOR SHOW PROGRAM

The lighting of the door with multi coloured LEDs makes the sun shower unique and desirable. The choice between single colours or multi coloured animation always offers new possibilities for renewal.

COLOR SHOW PROGRAM

L'illuminazione della porta tramite LED multicolori rende la doccia solare unica e desiderabile. La scelta fra i singoli colori od un'animazione a più colori offre sempre nuove possibilità di rinnovamento.



VIBRO PROGRAM
 It is an oscillating platform that thanks to the possibility to choose from 5 programs (welcome plan - high impact - full tonic - body drain - slimming plan) turns the tanning moment also into a healthy physical activity and muscle stimulation.

VIBRO PROGRAM
 È una pedana oscillante che grazie alla scelta fra i 5 programmi (welcome plan - high impact - full tonic - body drain - slimming plan) fa del momento dell'abbronzatura anche un'occasione per una sana attività fisica ed una stimolazione muscolare.

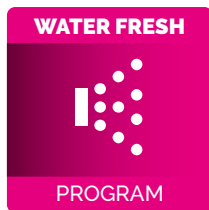

WATERFRESH PROGRAM
 Not just tanning but wellness too, a pleasant cool mist is atomized at programmed intervals to restore the body and spirit and improve the tan.

WATERFRESH PROGRAM
 Non solo abbronzatura ma anche benessere, una piacevole freschezza viene nebulizzata ad intervalli programmati, ritemperando corpo e sensi e coadiuvando l'abbronzatura.



SENSITIVE TOUCH PROGRAM
 With the exclusive Sensitive Touch Program keyboard, the interaction between the client and the screen is complete. The large screen and the intuitive and backlit functions allow an easy and complete management by the customer. Even in case of heavy use, the screen does not wear out.

SENSITIVE TOUCH PROGRAM
 Con l'esclusiva tastiera Sensitive Touch Program, l'iterazione tra il cliente e lo schermo è completa. Il grande schermo e le funzioni retroilluminate ed intuitive permettono una gestione da parte del cliente facile e completa. Anche in caso di uso intenso lo schermo non si usura.

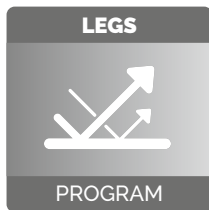

LEGS PROGRAM
 With the reflecting mirror platform it is much easier to tan the legs.

LEGS PROGRAM
 Con la pedana specchiata riflettente l'abbronzatura delle gambe viene ottimizzata.



IP INTELLIGENT PROGRAM
 The personalized regulation of the electronic ballasts allows to reduce energy consumption and to increase the lamps life. This system guarantees money saving, lower CO₂ emissions and lower environmental impact.

IP INTELLIGENT PROGRAM
 La regolazione personalizzata degli alimentatori elettronici, permette di diminuire i consumi di energia e di aumentare la durata della vita delle lampade. Questo sistema garantisce un risparmio economico, minori emissioni di CO₂ e minor impatto ambientale.



ELECTRONIC PROGRAM
 Thanks to the static electronic system, energy savings up to 20% can be achieved without minimizing tanning performance

ELECTRONIC PROGRAM
 Grazie al sistema elettronico statico si ottiene fino al 20% di risparmio energetico senza ridurre minimamente la performance abbronzante



PERSONAL TANNING PROGRAM
 Soft, Medium and High are the three personalized tanning programs. The customer can choose the desired tan with a simple touch of a finger

PERSONAL TANNING PROGRAM
 Soft, Medium e High sono i tre programmi di abbronzatura personalizzata. Il cliente potrà scegliere l'abbronzatura desiderata con un semplice tocco di un dito

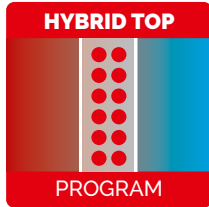

HYBRID TOP PROGRAM
 High-intensity Collagen LEDs provide a beauty treatment in the areas of the face, neck and décolleté during tanning sessions

HYBRID TOP PROGRAM
 I LED Collagen ad alta intensità forniscono un trattamento di bellezza nelle aree del viso, collo e décolleté durante la seduta abbronzante



**TUNE RADIO +
BLUETOOTH**
SINTONIZZATORE
RADIO + BLUETOOTH

VOLUME
VOLUME

VENTILATION
VENTILAZIONE

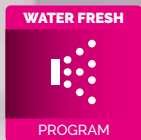

WATERFRESH



THREE LEVEL TANNING
TRE LIVELLI DI ABBRONZATURA

This function is active only
if coupled with IP Intelligent Program

Questa funzione è attiva solo
se abbinata a IP Intelligent Program



Tecnosole[®]
your beauty way ●●●●



SENSITIVE TOUCH PROGRAM

With “**Sensitive Touch Program**” everything becomes easier for the customer, the interaction between the user and the screen is complete, the convenience of the device usage feels natural and reassuring.

With the “**Sensitive Touch Program**” technology the buttons lose any physical connotation now they have larger dimensions and are simpler to use. The diminished dependence on physical elements makes contact more secure and immediate and all the screen space is dedicated to displaying functions.

“**Sensitive Touch Program**” technology, even under heavy use, the buttons do not wear out, thus eliminating replacement costs of traditional keyboards.

With radio and Bluetooth connection the entertainment is assured and the session time pass by pleasantly.

Con “**Sensitive Touch Program**” tutto diventa più semplice per il cliente; l'interazione tra l'utente e lo schermo è completa, la praticità e comodità del dispositivo risulta naturale e rassicurante.

Con la tecnologia “**Sensitive Touch Program**” i pulsanti hanno perso ogni tipo di connotazione fisica, hanno dimensioni più evidenti e risultano quindi semplici da selezionare.

La minor dipendenza da elementi fisici rende il contatto più sicuro ed immediato e lo spazio sullo schermo è interamente dedicato alle funzioni.

Anche con un uso molto intenso di “**Sensitive Touch Program**” la tastiera non si usura, eliminando così i costi di sostituzione di una tastiera tradizionale.

Con la radio e la connessione Bluetooth l'intrattenimento è assicurato ed il tempo della seduta trascorre piacevolmente.







WITH
TECNOSOLE
WHATEVER
YOUR **CHOICE**
YOU HAVE
CHOOSE
THE **TOP.**

**CON TECNOSOLE QUALUNQUE SIA
LA TUA SCELTA HAI SCELTO IL TOP.**

Tecnosole[®]
your beauty way ●●●

K: SUN

THE WINNING CHOICE

LA SCELTA VINCENTE



K Sun - in its three versions, Beauty, Diamond and Exclusive - is the result of the perfect combination of technology and Made in Italy design.

All versions have been designed to give the customer the maximum in terms of tanning and relaxation, and all have in common the elliptical shape, the 2-metre lamps (to tan even the tallest people), the powerful body ventilation separate from the lamp ventilation, the absence of shaded areas inside the sun shower and the sound system with radio and Bluetooth.

Both the Diamond and Exclusive models have an electronic switch to turn on the lamps and the multi-colour LED lighting on the doors, while the Exclusive model has the Sensitive Touch keypad with Top Sound Program and the collagen LED Hybrid Program system as standard.

The **Hybrid Program** combines UV lamps and collagen+UV lamps with red light Collagen LED. This combination provides excellent results, as tan looks intense and natural, and at the same time offers a beauty treatment that leaves the skin softer and more hydrated, while the smell of melanin that develops during the tanning session is reduced.

The **Water Fresh Program** system refreshes and moisturizes the skin for a session of pure wellness.

The **Vibro Program** platform accelerates metabolism and blood circulation helping the tanning process. Vibro Program tones legs and buttocks and the 5 programs - ranging from soft to strong - allow to choose the level of physical activity desired.

The **Intelligent Program** system, thanks to the adjustable power, ensures lamps last longer and guarantees energy savings.

With the **Personal Tanning Program**, always combined with the Intelligent Program, your client can choose between three levels of tan, ranging from soft to high.

K Sun nelle sue tre versioni: Beauty, Diamond ed Exclusive è il frutto di una perfetta combinazione di tecnologia e design Made in Italy.

Tutte le versioni sono state concepite per dare al cliente il massimo in termini di abbronzatura e relax, tutte hanno in comune: la forma ellittica, le lampade da 2 m per abbronzare anche le persone più alte, la potente ventilazione corpo separata da quella delle lampade, l'assenza di zone d'ombra all'interno della doccia solare, il sistema audio con radio e Bluetooth.

I modelli Diamond ed Exclusive hanno in comune l'accensione elettronica delle lampade e l'illuminazione multi colore delle porte con LED, mentre l'Exclusive ha di serie la tastiera Sensitive Touch con Top Sound Program ed il sistema di LED al collagene Hybrid Program.

Hybrid Program abbina lampade UV e lampade collagene+UV con LED a luce rossa Collagen. Questa combinazione ottimizza i risultati in termini di abbronzatura che risulta intensa e naturale ed offre nel contempo un trattamento di bellezza, la pelle si mantiene più morbida ed idratata, l'odore della melanina che si sviluppa durante la seduta abbronzante si riduce.

Il sistema **Water Fresh Program** rinfresca ed idrata la pelle per una seduta di puro benessere.

La pedana **Vibro Program** accelera il metabolismo e la circolazione sanguigna favorendo anche l'abbronzatura. L'azione di Vibro Program tonifica gambe e glutei, i 5 programmi permettono di scegliere l'attività fisica più idonea, da soft a strong.

Il sistema **Intelligent Program** assicura una vita più lunga alle lampade ed un risparmio energetico grazie alla gestione della potenza.

Con **Personal Tanning Program**, sempre abbinato con il sistema Intelligent Program, il vostro cliente potrà scegliere fra tre livelli di abbronzatura da soft ad high.

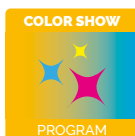
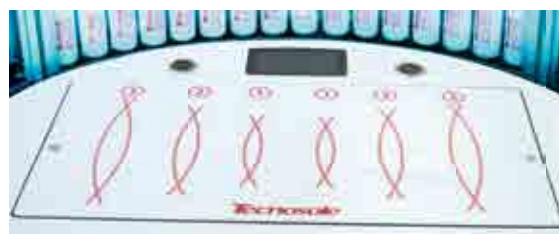

KSUN DIAMOND and KSUN EXCLUSIVE with LED illuminated door chosen from various colours, the intermittent option also available. KSUN DIAMOND e KSUN EXCLUSIVE con porta illuminata a led a scelta tra varie colorazioni anche intermittenti.

VERSION:



K: SUN
 B E A U T Y



STANDARD EQUIPMENT



K: SUN
 D I A M O N D



STANDARD EQUIPMENT



OPTIONAL



Top Sound Program is coupled with the Sensitive Touch Program
Top Sound Program è abbinato al Sensitive Touch Program
Legs Program must always added to Sensitive Touch Program
Legs Program è sempre da aggiungere a Sensitive Touch Program



K: SUN
 E X C L U S I V E



STANDARD EQUIPMENT



OPTIONAL



X:SUN

UNMATCHED SIZE AND PERFORMANCE

DIMENSIONI E PRESTAZIONI SENZA EGUALI



The generous internal dimensions and the 54 and 57 lamps, depending on the model, make X Sun the ideal shower for those who are looking for large spaces and great tanning power.

In all versions your customers will be able to count on 2-metre lamps (to tan even the tallest people), the powerful body ventilation separate from the lamps ventilation, the absence of shaded areas inside the sun shower and the sound system with radio and Bluetooth.

Both the Diamond and Exclusive models have an electronic switch to turn on the lamps and the multi-colour LED lighting on the doors, while the Exclusive model has the Sensitive Touch keypad with **Top Sound Program** and the collagen LED **Hybrid Program** system as standard.

Hybrid Program combines UV lamps and collagen+UV lamps with red light Collagen LED.

This combination provides excellent results, as tan looks intense and natural and at the same time offers a beauty treatment that leaves the skin softer and more hydrated, while the smell of melanin that develops during the tanning session is reduced.

The **Water Fresh Program** system refreshes and moisturizes the skin for a session of pure wellness.

The **Vibro Program** platform accelerates metabolism and blood circulation helping the tanning process. **Vibro Program** tones legs and buttocks and the 5 programs - ranging from soft to strong - allow to choose the level of physical activity desired.

The **Intelligent Program** system, thanks to the adjustable power, ensures that lamps last longer and guarantees energy savings.

With the **Personal Tanning Program**, always combined with the Intelligent Program, your client can choose between three levels of tan ranging from soft to high.

Le generose dimensioni interne e le 54 o 57 lampade, secondo il modello prescelto, fanno del modello X Sun la doccia ideale per coloro che ricercano ampi spazi e grande potere abbronzante.

In tutte le versioni i vostri clienti potranno contare sulle lampade da 2 m per abbronzare anche le persone più alte, la potente ventilazione corpo separata da quella delle lampade, l'assenza di zone d'ombra all'interno della doccia solare ed il sistema audio con radio e Bluetooth.

I modelli Diamond ed Exclusive hanno in comune l'accensione elettronica delle lampade e l'illuminazione multi colore della porta con LED, mentre X Sun l'Exclusive ha di serie la tastiera **Sensitive Touch Program** con **Top Sound Program** ed il sistema di LED al collagene **Hybrid Program**.

Hybrid Program abbina lampade UV e lampade collagene+UV con i LED a luce rossa Collagen. Questa combinazione ottimizza i risultati in termini di abbronzatura che risulta intensa e naturale ed offre nel contempo un trattamento di bellezza, la pelle si mantiene più morbida ed idratata, l'odore della melanina che si sviluppa durante la seduta abbronzante si riduce.

Il sistema **Water Fresh Program** rinfresca ed idrata la pelle per una seduta di puro benessere.

La pedana **Vibro Program** accelera il metabolismo e la circolazione sanguigna favorendo anche l'abbronzatura. L'azione di **Vibro Program** tonifica gambe e glutei, i 5 programmi permettono di scegliere l'attività fisica più idonea, da soft a strong.

Il sistema **Intelligent Program** assicura una vita più lunga alle lampade ed un risparmio energetico grazie alla gestione della potenza.

Con **Personal Tanning Program**, sempre abbinato con il sistema **Intelligent Program**, il vostro cliente potrà scegliere fra tre livelli di abbronzatura da soft ad high.

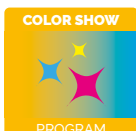
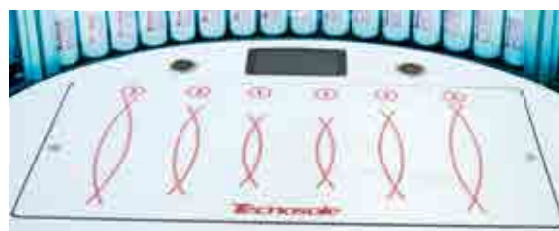

XSUN DIAMOND and XSUN EXCLUSIVE with LED illuminated door chosen from various colours, the intermittent option also available. XSUN DIAMOND e XSUN EXCLUSIVE con porta illuminata a led a scelta tra varie colorazioni anche intermittenti.

VERSION:



X:SUN
 B E A U T Y



STANDARD EQUIPMENT



X:SUN
 D I A M O N D



STANDARD EQUIPMENT

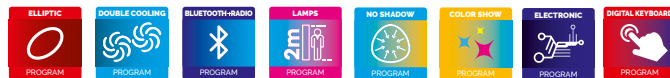

OPTIONAL



Top Sound Program is coupled with the Sensitive Touch Program
Top Sound Program è abbinato al Sensitive Touch Program
Legs Program must always added to Sensitive Touch Program
Legs Program è sempre da aggiungere a Sensitive Touch Program



X:SUN
 E X C L U S I V E



STANDARD EQUIPMENT



OPTIONAL



STYLE

THE CHARM OF AN EXCLUSIVE STYLE

IL FASCINO DI UNO STYLE ESCLUSIVO



Choose the model of Style you prefer; they all offer the same excellent performances. Your customers will just need a glance to fall in love with Style's pure lines and Made in Italy design. All versions are designed to provide the best tanning and relaxing results during the session.

All versions feature 2-metre lamps (to tan even the tallest people), the powerful body ventilation separate from the lamps ventilation, the absence of shaded areas inside the sun shower and the sound system with radio and Bluetooth.

Diamond and Exclusive models, have an electronic switch to turn on the lamps and the multi-colour LED lighting on the doors, while the Exclusive model has the Sensitive Touch keypad with Top Sound Program and the collagen LEDs Hybrid Program system as standard.

Hybrid Program combines UV lamps and collagen+UV lamps with red light Collagen LED.

This combination provides excellent results, as tan looks intense and natural, and the skin is softer and more hydrated; it also reduces the smell of melanin that develops during the tanning session.

The Water Fresh Program system refreshes and moisturizes the skin for a session of pure wellness.

The Vibro Program platform accelerates metabolism and blood circulation helping the tanning process. Vibro Program tones legs and buttocks; the 5 programs - ranging from soft to strong - allow to choose the level of physical activity desired.

The Intelligent Program system, thanks to the adjustable power, ensures that lamps last longer and guarantees energy savings.

With Personal Tanning Program, always combined with the Intelligent Program, your client can choose between three levels of tan, ranging from soft ad high.

Scegli la Style nel modello che preferisci, le prestazioni saranno sempre al top. Ai tuoi clienti basterà uno sguardo per innamorarsi delle linee pure ed il design made in Italy. Tutte le versioni sono state pensate per dare il massimo in termini di abbronzatura e relax durante la seduta: lampade da 2 m per abbronzare anche le persone più alte, la potente ventilazione corpo separata da quella delle lampade, l'assenza di zone d'ombra all'interno della doccia solare ed il sistema audio con radio e Bluetooth sono comuni nelle versioni: Beauty, Diamond ed Exclusive.

I modelli Diamond ed Exclusive hanno in comune l'accensione elettronica delle lampade e l'illuminazione multi colore della porta con LED, mentre Style Exclusive ha di serie la tastiera **Sensitive Touch Program** con **Top Sound Program** ed il sistema di LED al collagene **Hybrid Program**.

Hybrid Program abbina lampade UV e lampade collagene+UV con i LED a luce rossa Collagen. Questa combinazione ottimizza i risultati in termini di abbronzatura, che risulta intensa e naturale, la pelle si mantiene più morbida ed idratata, si riduce anche l'odore della melanina che si sviluppa durante la seduta abbronzante.

Il sistema **Water Fresh Program** rinfresca ed idrata la pelle per una seduta di puro benessere.

La pedana **Vibro Program** accelera il metabolismo e la circolazione sanguigna favorendo l'abbronzatura. L'azione di **Vibro Program** tonifica gambe e glutei, i 5 programmi permettono di scegliere l'attività fisica più idonea, da soft a strong. Il sistema **Intelligent Program** assicura una vita più lunga delle lampade ed un risparmio energetico grazie alla gestione della potenza. Con **Personal Tanning Program**, sempre abbinato con il sistema **Intelligent Program**, il vostro cliente potrà scegliere fra tre livelli di abbronzatura da soft ad high.

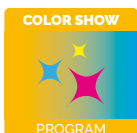

STYLE DIAMOND and STYLE EXCLUSIVE with LED illuminated door chosen from various colours, the intermittent option also available.
STYLE DIAMOND e STYLE EXCLUSIVE con porta illuminata a led a scelta tra varie colorazioni anche intermittenti.



VERSIONI:



STYLE BEAUTY



STANDARD EQUIPMENT



STYLE DIAMOND



STANDARD EQUIPMENT



OPTIONAL



Top Sound Program is coupled with the Sensitive Touch Program
Top Sound Program è abbinato al Sensitive Touch Program
Legs Program must always be added to Sensitive Touch Program
Legs Program è sempre da aggiungere a Sensitive Touch Program



STYLE EXCLUSIVE



STANDARD EQUIPMENT



OPTIONAL



CUSTOMIZE ONLINE YOUR EQUIPMENT!

PERSONALIZZA ONLINE
LA TUA APPARECCHIATURA!





The Tecnosole equipment configurator is online. Make yourself comfortable! Enter our website www.tecnosole.com, choose the model that best meets your needs and create your custom configuration, you can see all our models and check standard and optional equipment.

Tecnosole is always available to provide information and advice.

Il configuratore delle apparecchiature Tecnosole è on line. Mettiti comodo! Entra nel nostro sito www.tecnosole.com, scegli il modello che meglio soddisfa le tue esigenze e crea la tua configurazione personalizzata, potrai valutare tutti i nostri modelli verificando le dotazioni standard e gli optional.

Tecnosole è pronta a rispondere ad ogni tua richiesta di informazioni o consigli.

Welcome on the new Tecnosole configurator

THESE ARE THE RANGES OF TECNOSOLE SUN SHOWER AT YOUR DISPOSAL: CHOOSE THE MODEL THAT BEST FITS YOUR NEEDS AND CREATE YOUR CUSTOMIZED CONFIGURATION.

LOG INTO PRIVATE AREA

EXCLUSIVE AREA DEDICATED TO TECNOSOLE SALES & TECHNICAL REPRESENTATIVE

Username

Password

LOGIN

Remember Me

X:SUN

STYLE

K:SUN

XSUN LINE

STYLE LINE

KSUN LINE



crm.tecnosole.com

Tecnosole[®]
your beauty way ●●●

BEAUTY COLLAGEN

**633-NANOMETER LEDS TECHNOLOGY
TO INVIGORATE AND STIMULATE YOUR SKIN**

**TECNOLOGIA LED A 633 NM PER TONIFICARE
E STIMOLARE LA TUA PELLE**



The **light effects** on the skin tissue and on plants have long been studied by NASA researchers in the 90s. Once determined that the red light had managed to grow plants during space flights, experiments were also carried out in the field of medicine, with good results, thanks to the studies of Ronald W. Ignazio and Dr. Harry T. Whelan. About a quarter of all the proteins in our body are collagen. **It is collagen that gives our body structure by protecting it and supporting the softer tissues and connecting them with the skeleton.** The face, the neck and the cleavage are the parts of our body where the signs of the passage of time are most noticeable. A decreased production of collagen and dehydration are the main causes of the appearance of wrinkles and lines. The light at 633 nm of Beauty Collagen **stimulates the production of collagen**, the light is absorbed by our skin helping to give it back **elasticity and hydration**. The treatment is completed using the Beauty Gel cosmetic product to be used during the session and at home. Depending on the type of skin, 12 to 20 treatments are recommended, with times ranging from 15 to 20 minutes per session. In the first 3 weeks, we recommend 2 to 3 weekly applications. The maintenance consists of one session per week.

Gli **effetti della luce** sul tessuto cutaneo e sulle piante sono stati a lungo studiati dai ricercatori della NASA negli anni 90.

Una volta determinato che la luce rossa era riuscita a far crescere delle piante durante i voli spaziali, sono stati fatti esperimenti anche nel campo della medicina con buoni risultati, grazie agli studi di Ronald W. Ignazio e del Dott. Harry T. Whelan.

Circa un quarto di tutte le proteine del nostro corpo è collagene. **È il collagene che da struttura al nostro corpo proteggendolo e sostenendo i tessuti più molli e connettendoli con lo scheletro.**

Il viso, il collo ed il décolleté sono le parti del nostro corpo dove maggiormente si notano i segni del passare del tempo. Minor apporto di collagene e disidratazione sono la principale causa della comparsa delle rughe e dei segni di espressione.

La luce a 633 nm di Beauty Collagen **stimola la produzione di collagene**, la luce viene assorbita dalla nostra pelle contribuendo a ridarle **elasticità ed idratazione**. Completa il trattamento l'utilizzo del prodotto cosmetico Beauty Gel da usare durante la seduta e a casa. In relazione al tipo di pelle sono consigliati da 12 a 20 trattamenti con tempi che possono andare dai 15 ai 20 minuti. Nelle prime 3 settimane consigliamo dalle 2 alle 3 applicazioni settimanali. Il mantenimento consta di una seduta a settimana.

BEAUTY COLLAGEN IS A DEVICE SPECIFICALLY DESIGNED TO COMBAT THE SIGNS OF AGEING AND RESTORE FIRMNESS TO OUR SKIN.

BEAUTY COLLAGEN È UN'APPARECCHIATURA SPECIFICAMENTE STUDIATA PER CONTRASTARE I SEGNI DEL TEMPO E RIDARE TURGORE ALLA NOSTRA PELLE.

**LEDs ENERGY
AND 360° MOVEMENT**

ENERGIA LED E MOVIMENTO A 360°





TECHNICAL DETAILS

DATI TECNICI

STYLE

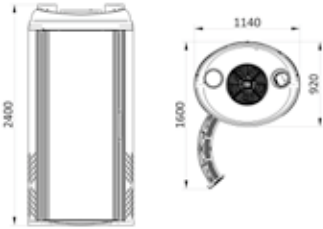

Technical data	Caratteristiche tecniche	52 TUBI BEAUTY	52 TUBI DIAMOND	50 + COLL EXCLUSIVE
Absorbed power	Potenza MAX assorbita Kw	9 Kw	11 Kw	10,8 Kw
Rated voltage	Tensione nominale	3P+N 400 V	3P+N 400 V	3P+N 400 V
Frequency	Frequenza	50 Hz	50/60 Hz	50/60 Hz
Body ventilation air flow rate	Portata ventilazione corpo	3400 m³/h	3400 m³/h	3400 m³/h
Ø Body ventilation fixing	Ø Fissaggio ventilazione corpo	450 mm	450 mm	450 mm
Technical compartment air flow	Portata ventilazione vano tecnico	850 m³/h	850 m³/h	850 m³/h
Ø Technical compartment fixing	Ø Fissaggio vent. vano tecnico	210 mm	210 mm	210 mm
Weight	Peso netto	290 Kg	210 Kg	210 Kg
External dimensions	Dimensione esterna	1140 x 1600 x 2400 mm H (with open door)		

K:SUN

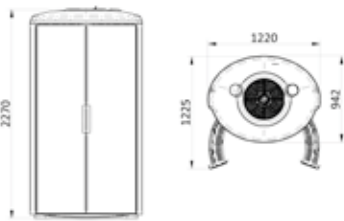

Technical data	Caratteristiche tecniche	44 TUBI BEAUTY	44 TUBI DIAMOND	48 TUBI BEAUTY	48 TUBI DIAMOND	48 + COLL EXCLUSIVE
Absorbed power	Potenza MAX assorbita Kw	7,7 Kw	9,4 Kw	8,3 Kw	10,2 Kw	10,4 Kw
Rated voltage	Tensione nominale	3P+N 400 V	3P+N 400 V	3P+N 400 V	3P+N 400 V	3P+N 400 V
Frequency	Frequenza	50 Hz	50/60 Hz	50 Hz	50/60 Hz	50/60 Hz
Body ventilation air flow rate	Portata ventilazione corpo	3400 m³/h	3400 m³/h	3400 m³/h	3400 m³/h	3400 m³/h
Ø Body ventilation fixing	Ø Fissaggio ventilazione corpo	450 mm	450 mm	450 mm	450 mm	450 mm
Technical compartment air flow	Portata vent. vano tecnico	390 m³/h	390 m³/h	390 m³/h	390 m³/h	390 m³/h
Ø Technical compartment fixing	Ø Fissaggio vent. vano tecnico	120 mm	120 mm	120 mm	120 mm	120 mm
Weight	Peso netto	270 Kg	220 Kg	270 Kg	220 Kg	220 Kg
External dimensions	Dimensione esterna	1220 x 1125 x 2270 mm H (with open door)				

X:SUN

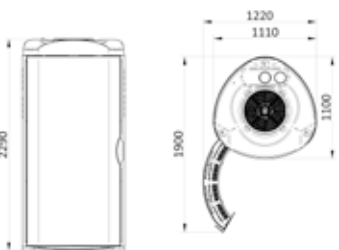

Technical data	Caratteristiche tecniche	54 TUBI BEAUTY	54 TUBI DIAMOND	57 TUBI BEAUTY	57 TUBI DIAMOND	54 + COLL EXCLUSIVE
Absorbed power	Potenza MAX assorbita	9,3 Kw	11,4 Kw	9,8 Kw	12 Kw	11,6 Kw
Rated voltage	Tensione nominale	3P+N 400 V	3P+N 400 V	3P+N 400 V	3P+N 400 V	3P+N 400 V
Frequency	Frequenza	50 Hz	50/60 Hz	50 Hz	50/60 Hz	50/60 Hz
Body ventilation air flow rate	Portata ventilazione corpo	3400 m³/h	3400 m³/h	3400 m³/h	3400 m³/h	3400 m³/h
Ø Body ventilation fixing	Ø Fissaggio ventilazione corpo	450 mm	450 mm	450 mm	450 mm	450 mm
Technical compartment air flow	Portata ventilazione vano tecnico	390 m³/h	390 m³/h	390 m³/h	390 m³/h	390 m³/h
Ø Technical compartment fixing	Ø Fissaggio vent. vano tecnico	120 mm	120 mm	120 mm	120 mm	120 mm
Weight	Peso netto	300 Kg	280 Kg	300 Kg	280 Kg	280 Kg
External dimensions	Dimensione esterna	1220 x 1900 x 2290 mm H (with open door)				

BEAUTY COLLAGEN

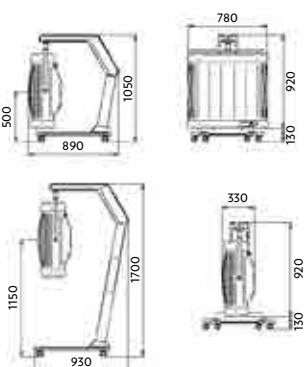

Technical data	Caratteristiche tecniche	BEAUTY COLLAGEN
Supply voltage	Tensione di alimentazione	220/240 Volt
Frequency	Frequenza	50/60 Hz
Total power	Potenza totale	1036 Watt
Low pressure lamps power	Potenza delle lampade a bassa pressione	14x40 = 560 Watt
Led bars power	Potenza barre led	3x22 = 66 Watt
Power lifting columns	Colonne di sollevamento elettriche	180x2 = 360 Watt
Net weight	Peso netto	62 Kg
Gross weight	Peso lordo	83 Kg



The company reserves the right to introduce all the technical and/or aesthetic modifications deemed necessary to their products without prior notice.

L'azienda si riserva il diritto di introdurre tutte le modifiche tecniche e / o estetiche ritenute necessarie per i prodotti senza preavviso.

Tecnosole[®]
your beauty way ●●●

www.tecnosole.com

TECNOSOLE S.r.l.

Via Fornace Il Strada, 24/B
35010 Arsego
di S. Giorgio delle Pertiche
Padova - Italy
T. +39 (0)49 9630771
info@tecnosole.com

